

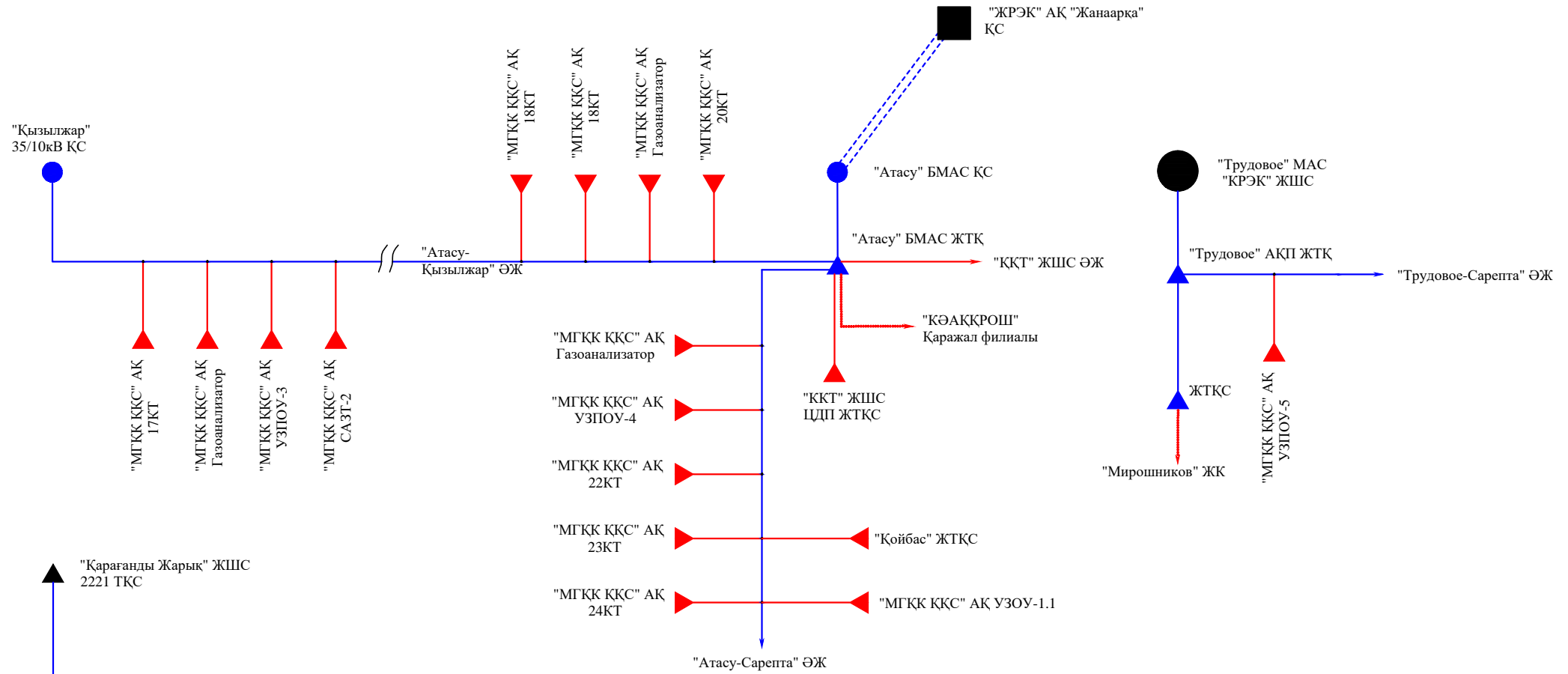









2021-2022жж Қарағанды МҚБ электр желілерінің қалыпты сұлбасы

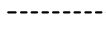

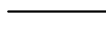
"Қарағанды Жарық" ЖШС
2221 ТҚС

ҚарМҚБ ӨҚКБ
ЖТҚС

"KazTransCom" АҚ

- | | | | | | |
|---|--------------------|---|---------------|---|-----------------------|
|  | 220кВ ҚС |  | 35кВ
ЭТӘЖ |  | Энергия таратушы ұйым |
|  | 110кВ ҚС |  | 10кВ
ЭТӘЖ |  | ҚарМҚБ |
|  | 35кВ ҚС |  | 0,4кВ
ЭТӘЖ |  | ҚарМҚБ субабоненттері |
|  | ЖТҚС, ЖТҚ, ТҚС10кВ | | | | |